

(1) SMR Code	Federal Stock Number	Description Reference number & mfg. code	Unit Of Meas.	Qty Inc In Unit	15-day organizational Maintenance alw				(7) Illustration	
					(a) 1-5	(b) 6-20	(c) 21-50	(d) 51-100	(a) Figure No.	(b) Item No.-
		2202—ACCESSORY ITEMS—Continued								
P-O	5310-929-6417	NUT, HEXAGON: MS24679-65 (96906)	EA	1					52	3
P-O	2540-058-3264	ARM, REAR VIEW MIRROR: long, (15 in. closed, 25 in. extended) assembly 583264 (19207)	EA	1					52	4
P-O	5310-732-0559	NUT: MS51968-8 (96906)	EA	1					52	5
P-O	5310-627-6128	WASHER: MS35335-21 (96906)	EA	1					52	6
P-O	5305-269-2807	BOLT: MS35298-64 (96906)	EA	1					52	7
P-O	5310-934-9751	NUT, PLAIN, HEXAGON: windshield wiper motor MS35650-302 (96906)	EA	4					52	8
P-O	5310-045-3296	WASHER, LOCK: windshield wiper motor MS35338-43 (96906)	EA	4					52	9
P-O	5315-423-2793	STUD, PLAIN: windshield wiper motor 927972 (12204)	EA	4					52	10
P-O	2540-262-7576	MOTOR, WINDSHIELD WIPER: vacuum type 500844 (21450)	EA	2					52	11
P-O	2540-054-7201	MIRROR: rear view, inside 547201 (19207)	EA	1					52	12
P-O	2540-050-0810	ARM, WINDSHIELD WIPER: 7½ inch to 12 inch assembly 500810 (19207)	EA	2					52	13
P-O	2540-255-9212	BLADE, WINDSHIELD WIPER: 10 inches long MS53048-10 (96906)	EA	2					52	14
P-O	5309-081-6676	SCREW, MACHINE: reflector MS35268-80 (96906)	EA	12					53	1

Current part is item (14) on diagram. Available at www.oshkoshequipment.com

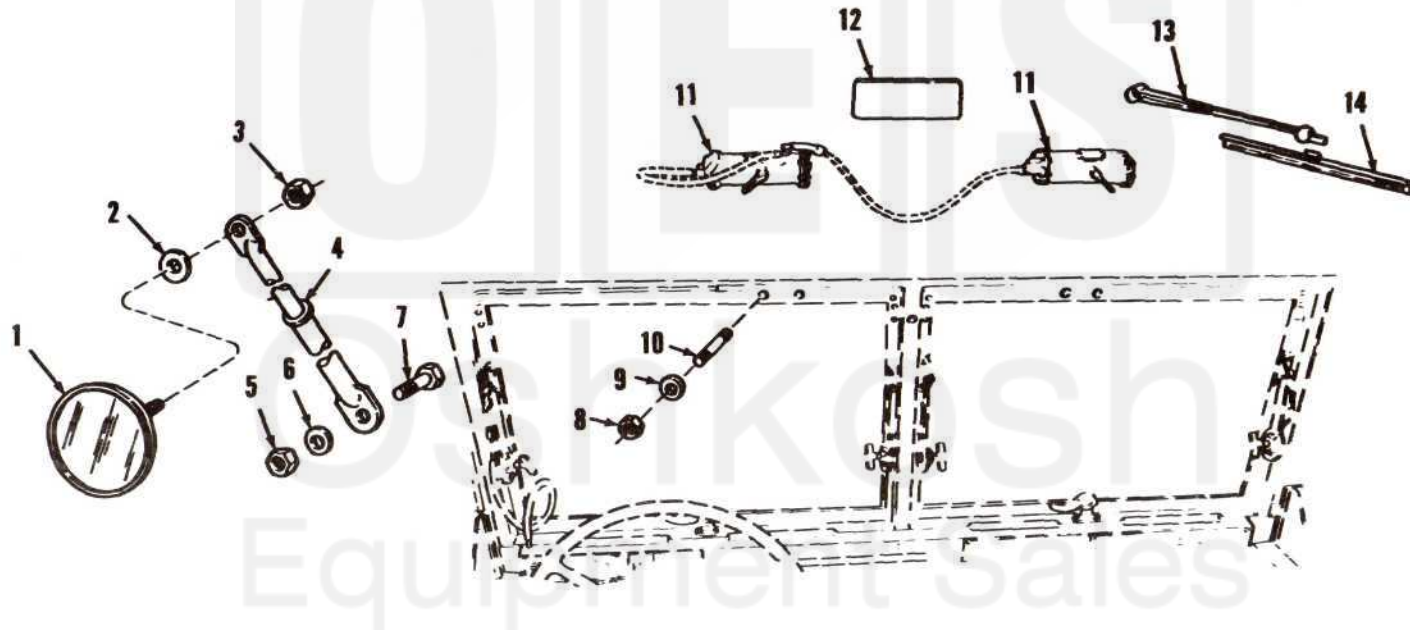

Figure 52. Windshield wipers and rear view mirrors.

Current part is item (14) on diagram. Available at www.oshkoshequipment.com

AT 40759